

Development of a Mobile Cardiac Wellness Application and Integrated Wearable Sensor Suite

Paul J Fortier

Benjamin Viall

Electrical and Computer Engineering
University of Massachusetts Dartmouth
North Dartmouth, MA., USA

pfortier@umassd.edu

bviall@umassd.edu

Abstract— This paper describes the design process for a mobile patient-centric, self-monitoring, symptom recognition and self intervention system supporting chronic cardiac disease management. The system design was undertaken in five phases, refining our concept from crude prototype to brass-board system ready for product development and experimental testing. Our system is composed of a mobile smart phone and wearable sensor suite linked through blue tooth and cell phone technology to a backend data repository, data mining, knowledge discovery, knowledge evolution and knowledge processing system, providing clinical data collection, procedural collection, intervention planning, medical situational assessment and health status feedback for users. The system aids patients in learning to recognize disease specific symptoms and understand the effect on their health of adherence to interventions.

Keywords- *Collaboration tools, Sensor Design, Cardiac Wellness*

I. INTRODUCTION

Cardiovascular disease represents a significant public health problem affecting approximately 6 million Americans last year alone at a cost of 37.2 Billion dollars [1]. Heart failure, as a chronic and progressive illness, primarily of the elderly, has a negative effect on patients' quality of life with symptoms affecting well being, limiting normal daily living activities, and increasing the risk of multiple hospitalizations [2]. Faulty self-care behaviors including the inability to recognize symptoms and seek timely treatment are linked to hospitalization in this population [3]. Self-care of heart failure is difficult for many patients since it involves daily monitoring of symptoms, dietary restrictions, and correctly taking multiple medications [4].

Symptom awareness and monitoring, important for self-care, are confounded by the often insidious yet subtle changes in severity of symptoms, as well as due to advanced age and cognition, leading to discounting of early symptoms of heart failure decompensation, such as fatigue and dyspnea, to aging [5].

Recent heart failure medical management advances include the use of implanted devices to provide early cues to

decompensation through monitoring of heart rate, fluid status, and heart rhythms [6]. Unfortunately, not all persons with heart failure are able to receive such devices for a variety of reasons including cost, eligibility and geographic proximity to a clinic that monitors such devices. Wearable low cost devices easily placed by a patient or clinician are needed to support more frequent access to real-time cardiac physiologic data [7].

A number of researchers are attempting to develop interventions to improve symptom recognition, interpretation and ultimately improve treatment seeking behaviors [8]. Before tailored, patient centric heart failure care models can be developed, more information is needed about the process of symptom recognition and the validity of health related feedback in improving self-care in heart failure patients. Currently, no research has shared data derived from technological monitoring processes with patients themselves with the goal of making them an active partner in the process of performing self-care. Increasing patient's ability to identify and report these correlates may increase the ability to develop interventions that improve symptom recognition and treatment seeking behaviors.

The problem with conventional out-patient post cardiac disease management is the inability to monitor and assess patient health status in real-time within the home setting. Most post hospitalization care protocols require patient visitation by a clinician to assess health and progress. These visitations occur sporadically and are not necessarily focused on patient needs. Patients in such home care settings do not typically comprehend their own disease status or changes correctly. Patients have not been trained before leaving the hospital environment on what symptoms are important and how to assess subtle, yet important changes to these symptoms.

Our research fills the need for tools that aid both the patient and clinician in improving individual patient outcomes. The primary function of our tool is to assist patients through simple interactions and feedback in learning how to recognize the relative status of their health condition, to recognize and understand symptom and status changes either positively or negatively and to develop and put into

place self interventions to implement in between clinical health care professional encounters.

II. BACKGROUND

The theoretical framework that guides our study is the situation specific Theory of Heart Failure Self-Care, fig. 1. The theory posits that self-care is a naturalistic decision making process consisting of two types of behaviors: self-care maintenance and self-care management. In self-care maintenance, persons with heart failure follow the advice of a provider to take medications, follow a diet and make healthy lifestyle choices such as getting a flu shot [9,10]. Self-care management is an active process of heart failure symptom monitoring that begins with recognizing symptoms, evaluating the symptoms, deciding on a course of action, taking action and finally evaluating the effectiveness of the selected course of action (treatment evaluation). All of these behaviors require practice to develop skills and confidence in the ability to undertake the behaviors.

The self-care management portion of the model is patient-centered with the patient making treatment decisions based on knowledge and context. Often self-care decision making is embedded in other processes and not a discrete task thus increasing the complexity of the process.

Symptom recognition, evaluation and treatment implementation are critical yet extremely hard to realize goals in chronic heart failure patient populations [11]. Prior research suggests that a number of factors influence self-care behaviors in persons with heart failure. First, patients fail to recognize the symptoms of an acute heart failure exacerbation leading to delay in seeking treatment, resulting in costly hospitalizations [12,13]. Second, knowledge about appropriate self-care actions to maintain health in heart failure is low [14]. Finally, making linkages between acute symptoms and appropriate actions requires practice and education beyond the hospitalization period.



Figure 1: Theory of heart Failure Self-care [10]

In patients with cognitive changes, the ability to make linkages between symptoms and actions may require new interventions to support the development of this critical self-care behavior.

III. MOBILE CHRONIC HEART FAILURE MONITORING AND ASSESSMENT

In our mobile monitoring system, physiologic and perceptual mobile instruments are used to gather patient specific information. Gathered data include, physiologic measurements, perceptual measurements, psychosocial measurements, health history and ontological information. This information is collected and fused into our system’s knowledge base using four forms of case equivalence (structural equivalence, functional equivalence, conceptual equivalence and temporal equivalence) forming new clinical use cases mined for new clinical knowledge [15]. The detection of patterns and sequences in time oriented clinical data is an important component of our analysis and takes into account subtle differences in how individual patients react to their malady and care interventions. [16].

Health monitoring, wellness and assessment application algorithms use these and a variety of other data sets to assess patient status and develop patient-centered interventions. For example, the physiological data sets are collected through the wearable sensors, during home visits, during clinical visits and during unplanned health crisis events providing a means to construct a temporal map of the patient’s physiologic health viewable at any instance of time or range of time.

IV. SYSTEM DESIGN, ARCHITECTURE AND OPERATIONS

The need to develop a more effective and seamless integration of all forms of related data into health care delivery has been described for over a decade [17,18], with progress mostly in health care related business processes. Our System and user interface design included the nurse and patient from the beginning to improve on acceptance and use.

Clinical knowledge is created during interactions between the patient and the nurse, between a patient and automated system or nurse and automated system with all clinical events stored in a knowledge base, fig. 2. Patient centric medical knowledge is made available to nurses and patients to aid in outcome improvement through two collaborative applications [19,20,21].

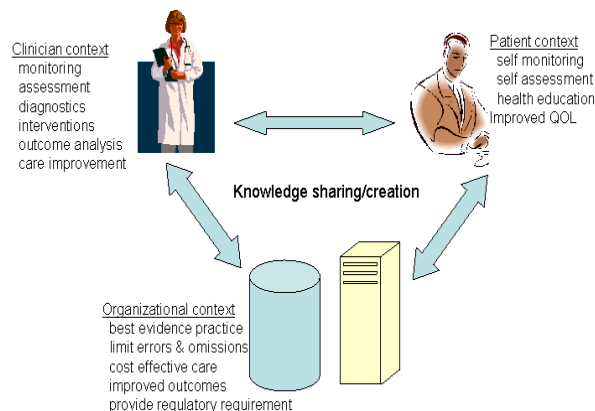

Figure 2: Clinical knowledge creation model

Our system is intended to mimic a knowledgeable mentor, guiding users (both patient's and nurses) through clinical data collection, situational assessment and decisions using information specific to the individual patient. Through iterative use, successful health management strategies can be learned, practiced and honed. Another desired outcome is the ability to uncover new practice knowledge using data mining methods which have seen very limited use to date in non-hospital based health care settings.

V. SYSTEM OPERATIONS AND USE

To improve both patient and clinicians ability to recognize subtle changes in symptoms requires more frequent collection, analysis and presentation of patient physiologic and perceptual data be performed. Our system uses a mobile smart phone and wearable sensor suite linked through blue tooth technology connected with a backend data repository, data mining and knowledge processing system, fig. 3, to improve data collection, real-time assessment and interventional decision support.

The front end patient and nurse mobile monitoring devices and patient wearable sensors act as the clinical data collection, procedural collection, intervention planning, medical situational assessment and instructional feedback platform. The backend inference engine is based on the integration of case-based and rule-based reasoning subsystems [22]. Clinical knowledge is represented as a set of data rules and associated meta-rules, ranked using evidence-based and usage relationships [23]. An approximate answer to a clinical problem is derived using rules and similarity computations [24,25,26] computed under four different contexts, depending on the phase of the decision process that the nurse or patients are in [15,22].

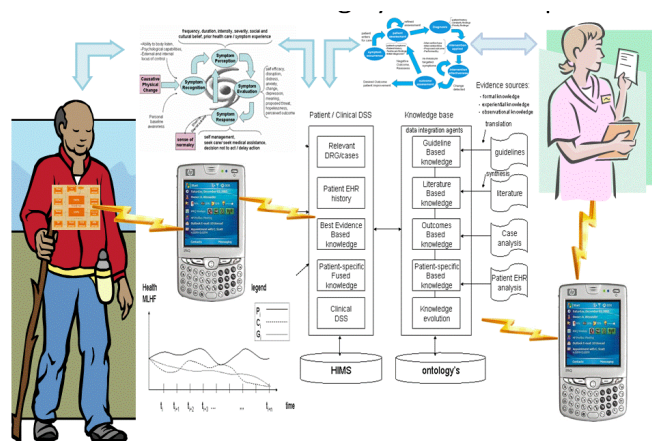

Figure 3: System conceptual architecture

In order to improve the efficiency of case lookup, multi-context clusters of cases are formed using declarative, procedural and semantic context. Similarity searches focus on multiple events temporal sequences to determine how this patient's present scenario relates to past cases [24] both

general and specific. For trend analysis the system examines how data items transition over time [23] and relate to past cases stored in the knowledge repository or represented in the knowledge ontology.

A nurse can invoke the patient collaboration application to perform a remote virtual home visit, to extract both spatial and temporal physiologic and perceptual measurements. A nurse, selects patients from those assigned and available on their device screen, selects and performs a variety of physical and psychological health assessments, evaluates patient status using collected and historic information and plans patient interventions focused on accomplishing desired patient outcomes (e.g. improved quality of life), fig. 4.

The clinical nursing mode application provides for active patient monitoring and extraction of stored and real-time measurements, configurable as an automated process. A second application supports nurse visual assessment of assigned patients. At the highest view, a nurse can request visual annotations (e.g. colored icons, green for all is well, yellow for some issues, orange for serious issues and red for dire issues) to indicate patient aggregated health assessment. Using visual patient representations a clinician can easily select a specific patient data set to drill down into for prior and present assessments using a variety of visual aids. For example, through trend analysis graphs, fig. 5, indicating improvement or degradation, or detailed physiologic graphs showing real-time measurements and historical measurements with expanded details available due to events such as a clinical office visit or hospitalization (e.g. blood workups, etc.).

The nurse can further choose intervention analysis and planning tools to examine which form of intervention is best suited for this specific patient [22]. The clinician can also reconfigure the patient wearable sensor suite or cell phone applications to change the periodicity of measurements as well as sensor sensitivity or even add new applications as they become available.

A second collaborative application supports patient self reporting and self analysis of health and wellness status. Patients select applications supporting lifestyle, physiologic and psychological assessments. Applications implement questionnaire based instruments such as the Duke Activity Status Index (DASI) or Heart Failure Somatic Awareness Scale index (HFSA). Once self evaluations are completed, patients can transmit data to the backend database or store locally. Self reporting and patient symptom self recognition is based on the symptom self recognition model [10], fig. 1. This model requires patients to be actively engaged in their health management. Using the tool set, a patient can further use visual assessment tools to examine progress of their self health management plan. Such feedback supports patient learning.

A third self management and intervention mobile application, allows a patient to explore a set of self interventions to (e.g. exercise regime, diet alteration, etc.)

aid in symptom and overall health management. Patients can

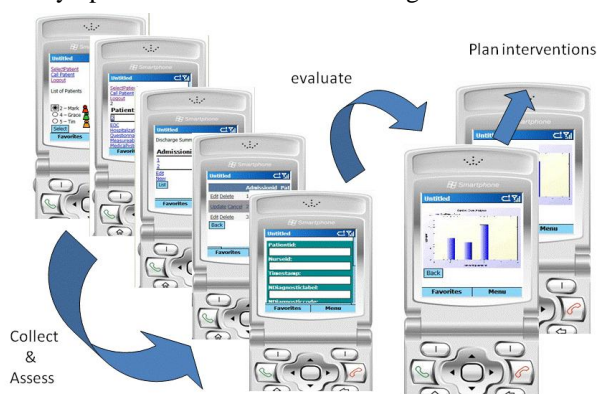

Figure 4: Clinician Example usage sequence

examine what the impact on their health could potentially be if they adhere to a specific intervention. Collaborative patient self management has been shown [27, 28, 29] to be an effective tool in helping patients understand, respond to and manage their health condition making them an active participant in their self care.

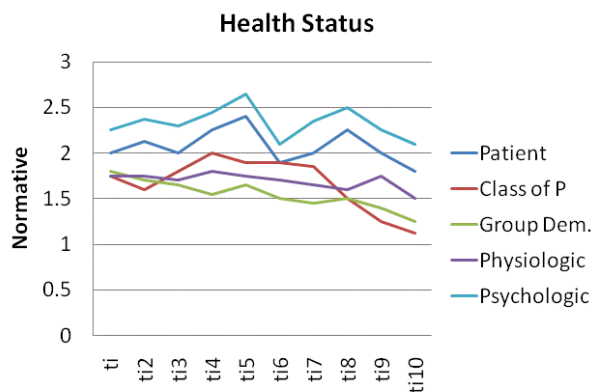

Figure 5: Trend analysis graph

VI. SYSTEM DESIGN

Phase one of five phases within our design odyssey (fig.6) involved the design of all sensors from scratch so that each could be designed with the end system on a chip (SOC) goal in mind. During this phase of design (completed fall 2010) all components were designed and tested using a microprocessor as the core computing engine, along with discrete printed circuit board (PCB) designs for each of the seven sensors.

The electro cardiogram (ECG) Sensor, fig. 7 (top left), was designed using a three lead concept. The sensor operates by measuring the electrical activity called action potential generated by the heart muscles during heart contractions, representing a graphical mapping of measurements taken of the heart's electrical activity over time. The signals generated are measured using electrodes that convert the electrical potential into a measureable voltage signal. Our sensor operates by extracting

measurements using a two lead approach with the third being body ground. The two electrodes rest on the right and left chest. The measured voltage is in the 1 to 5 mV range and is measured from the Ag/CL electrodes. The signal is then amplified using a high gain (e.g. 100) amplification factor.

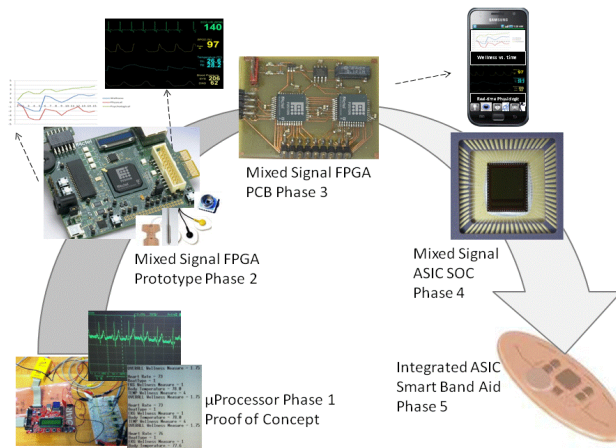

Figure 6: System Design Phases

The amplified signal is then isolated and filtered using a band pass filter (e.g. 0.04 – 150 HZ). The transducer output is then sent to a digital signal processor that extracts out the ECG signal, determines the principally important points (PIP) and then sends these to the core processing engine for ECG classification. Our sensor classifies ECG signals into one of six classes; normal, slow-fast heart rate, irregular heart rhythm, abnormality in ECG P wave, abnormality in ECG QRS wave, or abnormality within the ECG QRS wave and the ECG P waves combined.

The Oxygen Saturation sensor (SO₂) sensor was designed using tradition pulse oximetry concepts. Two light emitting diodes are used that produce red and infrared beams at 660 nm and 940 nm respectively. These signals are pulsed at approximately 30 times per second with a synchronous on cycle, followed by a pause cycle allowing for compensation due to ambient light. A photo-detector is used to measure the received light using the transmission method. The received red and infrared signals are extracted and used to compute a ratio of red to infrared light measured. This ratio is then used to compute the SO₂ percentage. In general typical ratios of .5 equate to an SO₂ of 100%, a ratio of 1 to an SO₂ rate of 82% and a ratio of 2 to an SO₂ of 0%. Our computations and calibrations use models well known in the industry. The SO₂ sensor front end design is shown in fig. 7 (bottom left).

The present sensors were implemented on a PCB and subsequently re-implemented in a mixed signal FPGA core. We are presently in the process of taking the core designs and redesigning for a mixed signal system on a chip (SOC) which will then be fabricated into our final form factor (e.g. the smart band aid, fig. 6, phase 5).

The third sensor is a simple temperature sensor. The design of the temperature sensor was accomplished using a 2 wire thin film resistive temperature detector (RTD) and a simple translation component that interprets the detected

voltages across the RTD wires and converts these into a temperature using a simple model. Using these basic sensors, all other cardiac measurements (e.g. blood pressure, blood flow, pulse rate, respiration rate) are derived using synthetic sensor concepts built using synthetic models [30].

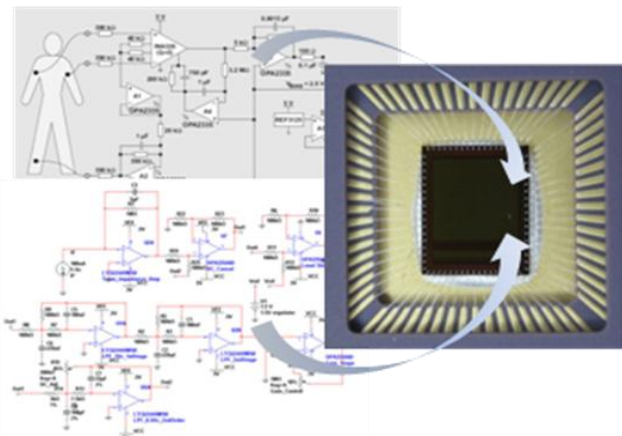

Figure 7: ECG/O2 Sensors Design and Integration

For example, to calculate the pulse rate the ECG wave interval is tracked and counted. The count of waveforms per minute is then used to compute a pulse rate averaged over time to reflect the clients pulse. Likewise for respiration rate, the ECG can be used to extract out a background variation signal in the amplitude of the ECG peaks in synch with the clients respiration rate.

Likewise the client’s blood pressure and blood flow can also be calculated from the ECG and SO₂ values generated from the sensors using relationships exhibited in the signals along with functions derived from the client’s physiology or using an additional acoustic transducer that measures flow variations. Our final design will choose one based on a least number of transducers principle.

The block diagram for our sensor is shown in fig.8. There are many novel features being developed as part of our system. First, we have adopted a cost cutting approach in terms of dollars, size, weight and power driven by the use of a minimum number of physical transducers to deliver the required measurements effectively and non-intrusively [31]. Secondly, we have gone for a single system on a chip design that will minimize the number of electronic elements that will be integrated into the final form factor (the smart band aid). Third, we have integrated the sensor processing with a cell phone mobile application to minimize the need for extensive on chip storage. Data storage needs will be limited to a maximum of three days of sensor readings based on present calculations.

The SOC sensor suite also consists of position and motion sensors integrated on chip allowing us to compensate for motion artifacts, reducing false alarms and producing more accurate readings based upon a patient’s true movements. The entire device is linked to a cell phone via a blue tooth transmit and receive component integrated on the chip. The only external component needed is the antenna. Three internal subsections are used to compute ECG, SO₂

and temperature readings from the raw transducer measurements. These measurements are then used in the synthetic sensor derivation unit (fig.8) to synthetically derive all other measurements. All physical and derived cardiac measurements are then used by the cardiac wellness engine (along with mobile phone based psychological assessments) to compute a patients relative cardiac health and cardiac health events (to signal adverse conditions automatically).

The board level version of the system, fig. 6 phase 3, will be completed by August 2011. This system was designed by a team of graduate computer engineering students, led by the authors who will complete all integration, testing and fielding of the system in an experimental study to begin in January of 2012. The final product, shown in fig.6 phase 5, is projected to be available after the completion of the experimental study which runs for an 18 month period.

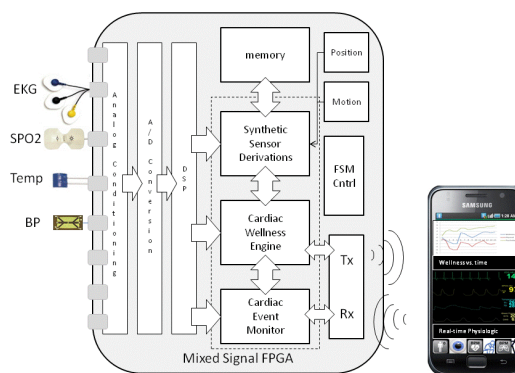

Figure 8: Wearable Sensor Architecture and Interface

VII. SUMMARY

We presented a novel mobile collaborative decision support tool consisting of an integrated non-intrusive sensor suite, mobile smart phone application and backend server. The system is designed for patient and clinical nurses and utilizes specific patient physiologic and psychosocial information and evidence-based nursing knowledge to offer real-time guidance to the patient and clinician mimicking that of an expert mentor. The system’s architecture is presented from three different viewpoints; an informational view, an operational perspective and a architectural design view. In the informational description, we utilized multiple sources of information to construct patient specific health assessments and wellness measures based on real-time and historic patient-centric data. In the operational system description, particular emphasis was placed on describing the steps patients and clinicians utilize in performing data collection actions, patient assessments, patient evaluations and intervention planning and execution.

ACKNOWLEDGMENT

This work was supported in part by the National Science Foundation under grant #EIA0218909 and NUWCDIVNPT under N00178-04-D-4109-N410.

REFERENCES

- [1] American Heart Association. Heart and Stroke Statistical Update 2009. Retrieved on 3/12/2010, <http://amhrt.org/statistics/index.html>.
- [2] American Heart Association, "Heart failure hospitalization rates rise among nation's seniors", American Heart Association heart disease and stroke statistics: 2008 update. <http://amhrt.org/statistics/index.html> Retrieved on 12/12/2008.
- [3] C. Annema, M. Luttik, and T. Jaarsma, "Reasons for readmission in heart failure: Perspectives of patients, caregivers, cardiologists and heart failure nurses." *Heart & Lung*, 38(5), 2009, pp. 427-434.
- [4] K. Grady, K. Dracup, G. Kennedy, D. Moser, M. Piano, L. Stevenson, and J. Young, "Team management of patients with heart failure: a statement for healthcare professionals", *Cardiovascular Nursing Council of the American Heart Association. Circulation* 2000; 102, pp. 2443-2456.
- [5] E. Stoller, L. Forster, R. Pollow, and W. Tisdale, "Lay evaluation of symptoms by older people: An assessment of potential risk". *Health Education Quarterly* 1993; 20, pp. 505-522.
- [6] E. Popojec and J. Bochmer, "On device monitoring and predicting heart failure exacerbation". *Current Treatment options in Cardiovascular Medicine* 2008; 10: pp. 371-379.
- [7] J. McManus, J. Salinas, and J. Holcomb, "The Ability to Capture "Real-Time" Physiologic Patient Data Using the Trauma Vitals System During Air Transport National Association of EMS Physicians, Registry Resort, Naples, FL from http://www.allacademic.com/meta/p61904_index.html, accessed 7/19/2011.
- [8] C. Jurgens, "Somatic awareness, uncertainty, and delay in care seeking in acute heart failure". *Research in Nursing & Health*, 2006; 29: pp 74-86.
- [9] B. Carlson, B. Riegel, and D. Moser, "Self care abilities of patients with heart failure". *Heart and Lung*, 30(5), 2001, pp. 351-359.
- [10] B. Riegel, and V. Dickson, "A situation-specific theory of heart failure self-care." *Journal of Cardiovascular Nursing*, 23, 2008, pp. 190-196.
- [11] C. Lee, N. Tkacs, and B. Riegel, "The influence of heart failure self care on health outcomes: Hypothetical cardio-protective mechanisms." *Journal of Cardiovascular Nursing*, 24(3), 2009, pp. 179-187.
- [12] L. Evangelista, K. Dracup, and L. Doering, "Treatment-seeking delays in heart failure patients". *The Journal of Heart and Lung Transplantation*, vol 19, 2000, pp. 932-938.
- [13] C. Jurgens, D. Moser, R. Armola, B. Carlson, K. Sethares, and B. Riegel, "Symptom Clusters of Heart Failure, Research in Nursing and Health, 2009, Vol. 32, No. 5, pp. 551-560.
- [14] N. Artinian, M. Magnan, M. Sloan, and M. Lange, "Self-care behaviors among patients with heart failure", *Heart & Lung*, 2002, vol 31, pp. 161-172.
- [15] T. Mitsa, P. Fortier, G. Yang, A. Shrestha, N. Dluhy, and E. O'Neill, "A Dynamic, Client-Centric Point-of-care System for the Novice Nurse", *Communications of the Association for Information Systems Journal, Information Systems and Healthcare XXI: Volume 19 Article 36, June, 2007. Available at <http://aisel.aisnet.org/cais/vol19/iss1/36>*
- [16] M. Prcela, D. Gamberger, and A. Jovic, "Semantic web ontology utilization for heart failure expert system design, *Medical Informatics Europe*, pp. 851-856, 2008.
- [17] J. Sensemeier, "Advancing the state of data integration in healthcare". *Journal of Healthcare Information Management*, 17(4), pp. 58-61, 2003.
- [18] P. Brown, and P. Sonken, "Evaluation of the Quality of Information Retrieval of Clinical Findings from a Computerized Patient Database Using a Semantic Terminological Model", *JAMIA*, vol. 7/4, 2000, pp. 392-403.
- [19] A. Chapyala, "Data Mining in Home Health Care Management, University of Massachusetts Dartmouth, ECE Technical Report UMD-ECE-TR-2009-101, 1/23, 2009.
- [20] R. Antony, "Development of Hit Ratio Algorithm and Matching Priority Index Supporting Patient Case Indexing, University of Massachusetts Dartmouth, ECE Technical Report UMD-ECE-TR-2009-102, 3/6, 2009.
- [21] A. Sishtla, "Similarity Search Using Frequent Case and Rule Based Indexing Techniques, University of Massachusetts Dartmouth, ECE Technical Report UMD-ECE-TR-2008-103, 3/28, 2008.
- [22] P. Fortier, "Improving student nurses clinical care experience through the use of a computerized Mobile hand-held Decision Support System", *IADIS mobile learning Conference*, April, 2008, pp. 10.
- [23] D. Wang, "Mining T-outliers in High Dimensional Time Series Financial Data". Ph.D. Dissertation, ECE department, University of Massachusetts Dartmouth. 2005.
- [24] B. Joshi, "Assessing the Significance of MLHFQ Attributes from a Spatial/temporal Perspective using Data Mining Techniques, University of Massachusetts Dartmouth, ECE Technical Report UMD-ECE-TR-2008-104, 12/16, 2008.
- [25] S. Chandran, "Improving Chronic Heart Failure Nurse Care Through Mobile Monitoring of Subtle Behavioral / Physiological Changes, University of Massachusetts Dartmouth, ECE Technical Report UMD-ECE-TR-2008-105, 12/16, 2008.
- [26] P. Narra, "Improving Chronic Heart Failure Patient Self Care Through Mobile Monitoring of Subtle Behavioral / Physiological Changes, University of Massachusetts Dartmouth, ECE Technical Report UMD-ECE-TR-2008-106, 12/16, 2008.
- [27] A. Jovicic, A. Holroyd-Leduc, and S. Straus, "Effects of self management intervention on health outcomes of patients with heart failure: a systematic review of randomized controlled trials, *BMC Cardiovascular Disorders*, Volume 6 Number 43, 2006, 8 pp.
- [28] T. Koerling, M. Johnson, R. Cody, and K. Aaronson, "Discharge education improves clinical outcomes in patients with chronic heart failure", *Circulation*, Volume 111, Number 2, 2000, pp 179-185.
- [29] T. Rector, S. Kubo, and J. Cohn, "Patients' self assessment of their congestive heart failure, Part 2: Content, reliability and validity of a new measure, *The Minnesota Living with Heart Failure questionnaire*", *Heart Failure*, Volume 3, 1987, pp 198-209.
- [30] P. Fortier and K. Dasari, "Examining the Role of Metadata in Testing IED Detection Systems, *International Test and Evaluation Association Journal - Sept 2009; Volume 30-3* pp. 421-433.
- [31] P. Fortier, O. Aljaroudi, P. Boddu, P. Chaiyasucheeva, R. Kanjee, A. Tannous, and W. Turner, "Design of a Flexible Cardiac Health Monitor - Supporting Patient/Clinician Subtle Cardiac Symptom Recognition", *Poster, IEEE Sensors 2011.*